

OPERATOR'S MANUAL

BINOCULAR

M19 W/E

(1240-00-930-3833)

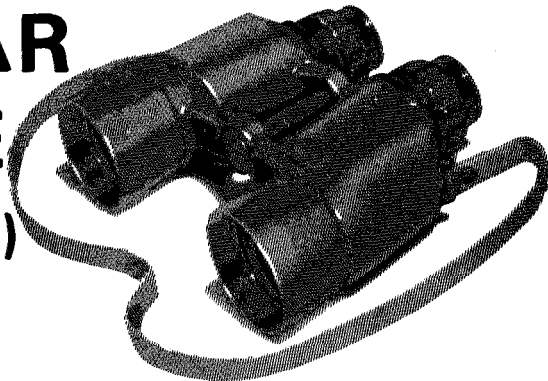

TM 9-1240-381-10

30 NOVEMBER 1977

WARNING

WHEN USING THE BINOCULAR, NEVER POINT IT DIRECTLY AT THE SUN. THE HEAT GENERATED BY THE FOCUSED RAYS OF THE SUN MAY CAUSE SERIOUS DAMAGE TO THE EYES AND TO THE OPTICAL ELEMENTS OF THE BINOCULAR.

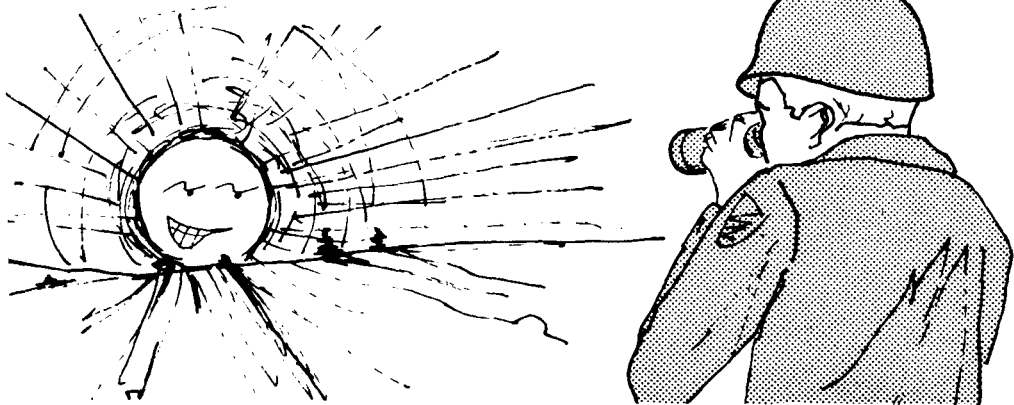

DESCRIPTION

BINOCULAR CASE
SHOULDER STRAP
BINOCULAR CASE
BELT STRAP
(NONREMOVABLE)

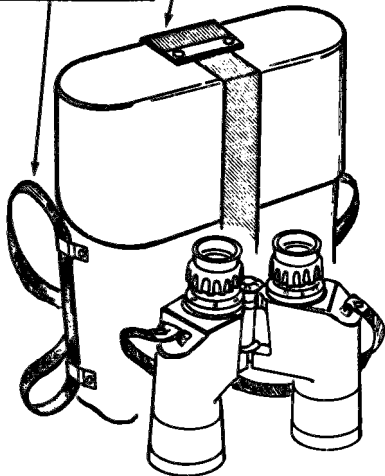

Note

The M1 filter (NSN 1240-00-769-1956) is an auxiliary piece of equipment which can be attached to the binocular eyecups.

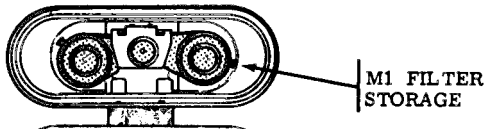

Binocular M19 is a lightweight, compact instrument intended for use in general field observation and fire detection. The left telescope of the binocular includes a horizontal and vertical reticle graduated in 10-mil increments.

The plastic carrying case provides protection for the binocular and is equipped with a belt strap and shoulder strap for easy portability. The binocular must be fully open and the objective assemblies facing up for insertion in the case.

DESCRIPTION (CONT'D)

- | | |
|--------------------------|-------------------------|
| 1. Eyepiece Assembly | 5. Objective Assembly |
| 2. Inter pupillary Scale | 6. L.H. Housing |
| 3. Diopter Scale | 7. Knurled Adapter Ring |
| 4. R.H. Housing | |

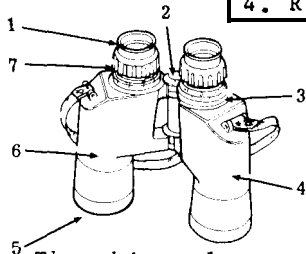

The binocular consists of two telescopes hinged at the center by an index pin and sleeve arrangement. Each telescope is comprised of an eyepiece assembly (1), a housing assembly (4 or 6) and an objective assembly (5). These assemblies are optically pre-aligned at the factory and must not be disassembled.

The friction necessary to maintain the proper interpupillary distance (distance between the eyes) is created by eleven rubber O-rings installed in the grooves of the index pin. Once this distance is set for your eye spacing, the reading on the scale (2) can be noted for future reference.

By rotating the knurled adapter ring (7) of the eyepiece, you can focus each telescope to accommodate your particular optical characteristics. The reading on each diopter scale (3) should then be noted for future reference.

GENERAL CHARACTERISTICS

Optical Characteristics

Objective Lens Diameter.....	50mm
Magnification.....	7X
Field of View.....	130 mils

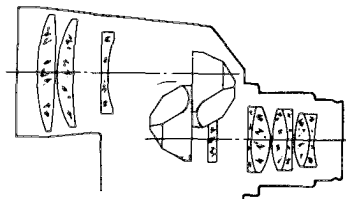

Physical Characteristics

Width (Open Position).....	190.5mm
Length.....	152.4mm
Thickness.....	63.5mm
Weight (Binocular Only).....	.966 kg
Weight (Case Only).....	.426 kg

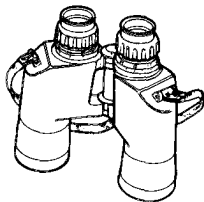

HANDLING PRECAUTIONS

DO'S Handle the binocular with care. Dropping or jarring the binocular can damage or misalign the optics. Use the neckstrap to protect against accidental dropping of the binocular.

Keep the binocular as clean and dry as possible and always store it in the carrying case when not actually in use.

Follow the instructions outlined in this TM to obtain the best possible usage and service from the binocular.

DO N'T S Do not use a dry cloth to clean the glass surfaces of the binocular. Specific cleaning instructions are given on page 11.

Do not attempt to open or close the binocular beyond its stop limits as this may damage internal and external parts.

Do not unnecessarily expose the binocular to severe weather elements. Special precautions are noted on pages 9 and 10.

Do not force the knurled adapter rings beyond marked diopter scale readings as this may damage internal parts.

OPERATING ADJUSTMENTS

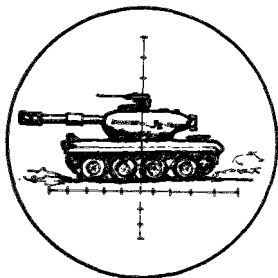

Interpupillary Adjustment

To obtain the proper interpupillary setting for your particular eye spacing, view the sky through the binocular. Then rotate the telescopes about the center hinge until both circular fields of view have merged into one circle. Note the reading on the interpupillary scale for future reference.

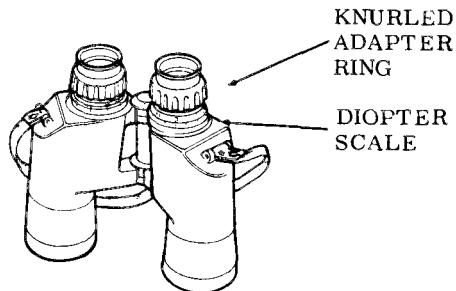

Diopter Adjustment

Each eyepiece of the binocular has a diopter scale graduated from plus 4 to minus 4 in half-diopter increments and can be adjusted to suit your eyesight characteristics. Rotate the knurled adapter rings to obtain the sharpest focus and note the scale readings for future reference.

NORMAL OPERATION

(1) Attach the carrying case to your belt by means of the belt strap. Be sure to snap the belt strap firmly on the bottom stud. For convenience, the carrying case can also be chest mounted.

(2) Remove the binocular from the case and immediately unwrap the neckstrap and place it about your neck.

(3) Close the telescopes of the binocular until the interpupillary index scale is at the proper setting for your use (see page 5).

(4) Rotate the eyepiece adapter rings to obtain the proper diopter settings on the diopter scale (see page 5).

(5) When sighting through the binocular, hold the binocular in a comfortable and stable position.

(6) Refer to pages 9 and 10 for precautions to be observed when unusual weather or atmospheric conditions prevail.

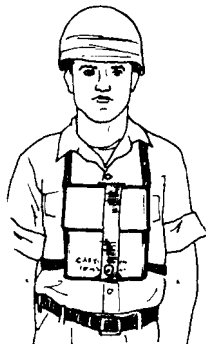

USE OF RETICLE

The left telescope of the binocular includes a horizontal and vertical scale reticle graduated in 10-mil increment unit markings (1 unit = 10 mils, 2 units = 20 mils, etc.).

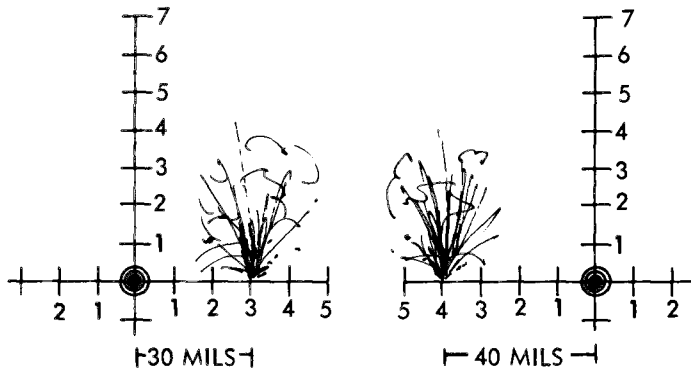
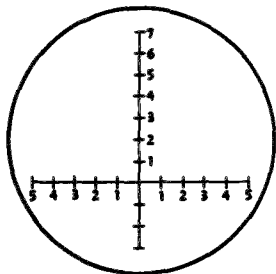

Fire corrections can be made by viewing the impact area and determining angular corrections by use of the left or right horizontal reticle scale.

USE OF RETICLE (CONT'D)

In determining range, if an object fills one 10-mil unit marking on the horizontal reticle scale and is known to be 10 meters wide, the object is 1000 meters away. If the same size object fills two unit markings (20 mils), it would be 500 meters away. The same formula can be used to determine range with the vertical reticle scale when the height of an object is known.

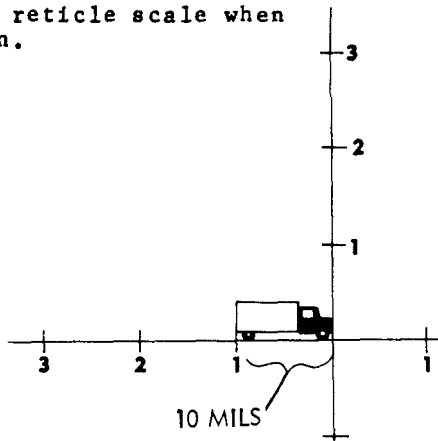
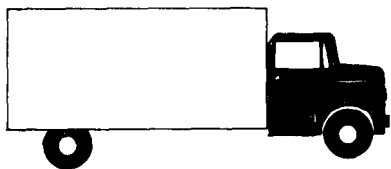

EXTREME COLD

(1) Avoid breathing directly on the optical elements of the binocular. The breath may condense and freeze.

(2) Do not expose the binocular to sudden and extreme temperature changes, such as carrying it directly from a well-heated area into sub-zero temperatures. Extreme temperature changes may cause the optical elements to crack.



EXTREME HEAT

(1) Do not allow the binocular to lie unprotected from the direct rays of the sun. The intensified heat may damage the binocular mechanisms.

(2) Place the binocular in its carrying case before entering an air-conditioned area. This will permit the binocular to cool down gradually and prevent condensation from forming.

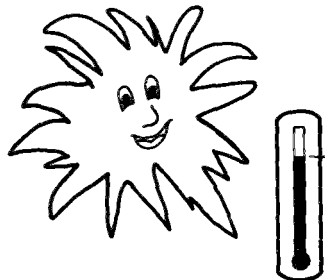

OTHER EXTREME CONDITIONS

Sand and Dust

(1) Always keep the binocular in its carrying case when not actually in use. Sand and dust will etch glass surfaces and can penetrate through the smallest openings, thereby causing damage to adjusting mechanisms.

(2) Upon completion of operations, remove all particles of sand and dust from optical elements as instructed on page 11.

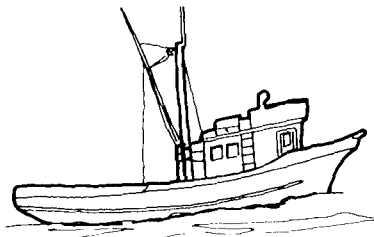
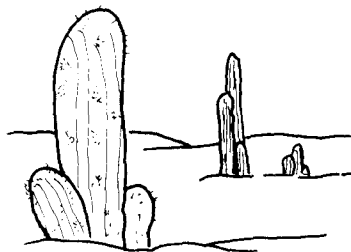

High Humidity or Salty Conditions

(1) Avoid exposing the binocular to direct salt spray. Salt water is extremely corrosive and can cause irreparable damage to the binocular.

(2) Always dry the binocular thoroughly after use and immediately store it in the carrying case.

CLEANING INSTRUCTIONS

Case and Binocular Exterior

Clean the exterior of the carrying case and the binocular (but not the lenses) with a lint-free cloth. Remove grease spots, fingerprints and other soil with soap and water and a well wrung-out cloth; then dry with a clean, lint-free cloth. Blow dirt and lint from case interior.

Optical Surfaces

Blow as much dust and dirt as possible from the exposed lens surfaces. Then, using a soft brush, brush across the surface with light, quick strokes, flicking the brush after each stroke to dislodge the dust it has picked up. When all visible particles of dust and dirt have been removed, moisten a piece of lens tissue with lens cleaner and gently wipe over the surface.

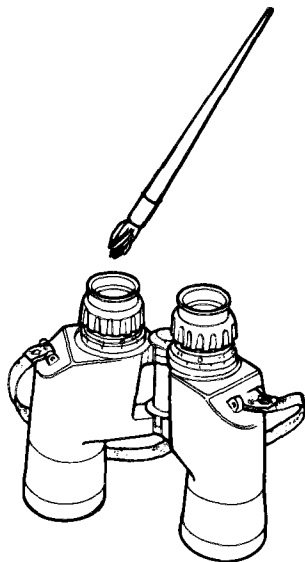

PREVENTIVE MAINTENANCE CHECKS AND SERVICES

Before Operation

(1) Check condition and security of all carrying straps. Inspect carrying case for visible damage and make sure case cover latches securely.

(2) Inspect binocular exterior and glass surfaces for cleanliness, cracks and scratches. Clean, if necessary (page 11).

After Operation

(1) If binocular and case have been exposed to inclement weather conditions, be sure to dry them thoroughly with clean, lint-free cloths.

(2) Clean the carrying case, the binocular exterior and the optical surfaces thoroughly as instructed on
page 11.

USE THE PROPER TOOLS !

- (1) Blower, Watchmaker's
(5120-00-254-4612)
- (2) Brush, Artist's
(8020-00-262-9099)
- (3) Brush, Artist's
(8020-00-224-8024)
- (4) Tissue, Lens
(6640-00-559-1385)
- (5) Tape, Masking
(7510-00-266-6711)
- (6) Cleaner, Lens
(6850-00-064-6287)

OPERATOR REPAIRS

Replacing Binocular Neckstrap

(NSN 1240-00-253-5893)

Unbutton the strap fasteners at the secured ends of the neckstrap and withdraw the neckstrap from the loops of the binocular. Install the new neckstrap in the reverse fashion, making certain that the neckstrap does not become twisted in the process.

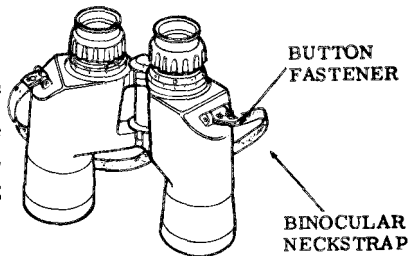

Replacing Binocular Case Shoulder Strap

(NSN 1240-00-253-5892)

Unfasten the binocular case shoulder strap and withdraw the shoulder strap from the loops of the carrying case. Install the new shoulder strap in reverse fashion, making certain that the shoulder strap does not become twisted in the process.

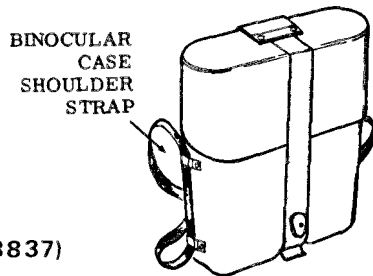

Replacing Binocular Case (NSN 1240-00-930-3837)

The binocular case should be replaced when damaged or unserviceable.

BINOCULAR STORAGE

(1) Clean the binocular and carrying case thoroughly as instructed on page

11.

(2) Before placing the binocular in the carrying case, pad all exposed glass surfaces with a few thicknesses of lens tissue and secure the pads in position with masking tape.

(3) Latch the case securely and store it on a shelf in a dry, well-ventilated area.

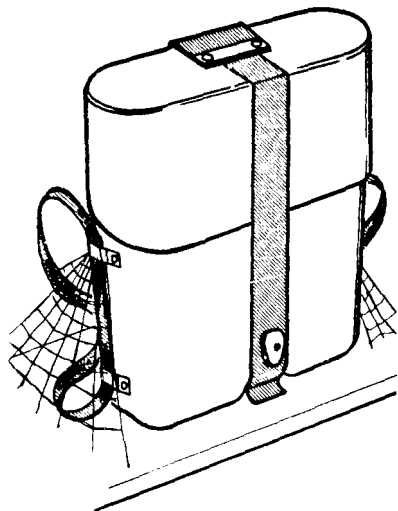

FORMS AND RECORDS

Maintenance forms, records, and reports which are to be used by maintenance personnel at all maintenance levels are listed in and prescribed by TM 38-750, The Army Maintenance Management System (TAMMS)

LET'S HEAR YOUR COMMENTS

Have you discovered any errors in this manual? Don't keep them to yourself . . . jot down the dope about them, including the page number and, if applicable, the illustration involved. Indicate exactly what you think is wrong and send your comments to

COMMANDER

U.S. ARMY ARMAMENT MATERIEL READINESS COMMAND

ATTN: DRSAR-MAS

ROCK ISLAND, IL. 61201

Technical Manual

No. 9-1240-381-10

TM 9-1240-381-10

HEADQUARTERS

DEPARTMENT OF THE ARMY

Washington, DC, 30 November 1977

This manual is published for the use of all concerned.

BY ORDER OF THE SECRETARY OF THE ARMY:

BERNARD W. ROGERS

General, United States Army

Chief of Staff

OFFICIAL:

J. C. PENNINGTON

Brigadier General, United States Army

The Adjutant General

DISTRIBUTION:

To be distributed in accordance with DA Form 12-41,
organizational maintenance requirements for Binoculars.

☆ GPO : 1993 O - 342-421 (63358)

RECOMMENDED CHANGES TO EQUIPMENT TECHNICAL PUBLICATIONS



THEN...JOT DOWN THE
DOPE ABOUT IT ON THIS FORM.
CAREFULLY TEAR IT OUT, FOLD IT
AND DROP IT IN THE MAIL.

SOMETHING WRONG WITH PUBLICATION

FROM: (PRINT YOUR UNIT'S COMPLETE ADDRESS)

DATE SENT

PUBLICATION NUMBER

PUBLICATION DATE

PUBLICATION TITLE

BE EXACT PIN-POINT WHERE IT IS

PAGE
NO.

PARA-
GRAPH

FIGURE
NO.

TABLE
NO.

IN THIS SPACE, TELL WHAT IS WRONG
AND WHAT SHOULD BE DONE ABOUT IT.

TEAR ALONG PERFORATED LINE

PRINTED NAME, GRADE OR TITLE AND TELEPHONE NUMBER

SIGN HERE

The Metric System and Equivalents

Linear Measure

1 centimeter = 10 millimeters = .39 inch
 1 decimeter = 10 centimeters = 3.94 inches
 1 meter = 10 decimeters = 39.37 inches
 1 dekameter = 10 meters = 32.8 feet
 1 hectometer = 10 dekameters = 328.08 feet
 1 kilometer = 10 hectometers = 3,280.8 feet

Weights

1 centigram = 10 milligrams = .15 grain
 1 decigram = 10 centigrams = 1.54 grains
 1 gram = 10 decigrams = .035 ounce
 1 dekagram = 10 grams = .35 ounce
 1 hectogram = 10 dekagrams = 3.52 ounces
 1 kilogram = 10 hectograms = 2.2 pounds
 1 quintal = 100 kilograms = 220.46 pounds
 1 metric ton = 10 quintals = 1.1 short tons

Liquid Measure

1 centiliter = 10 milliliters = .34 fl. ounce
 1 deciliter = 10 centiliters = 3.38 fl. ounces
 1 liter = 10 deciliters = 33.81 fl. ounces
 1 dekaliter = 10 liters = 2.64 gallons
 1 hectoliter = 10 dekaliters = 26.42 gallons
 1 kiloliter = 10 hectoliters = 264.18 gallons

Square Measure

1 sq. centimeter = 100 sq. millimeters = .155 sq. inch
 1 sq. decimeter = 100 sq. centimeters = 15.5 sq. inches
 1 sq. meter (centare) = 100 sq. decimeters = 10.76 sq. feet
 1 sq. dekameter (are) = 100 sq. meters = 1,076.4 sq. feet
 1 sq. hectometer (hectare) = 100 sq. dekameters = 2.47 acres
 1 sq. kilometer = 100 sq. hectometers = .386 sq. mile

Cubic Measure

1 cu. centimeter = 1000 cu. millimeters = .06 cu. inch
 1 cu. decimeter = 1000 cu. centimeters = 61.02 cu. inches
 1 cu. meter = 1000 cu. decimeters = 35.31 cu. feet

Approximate Conversion Factors

To change	To	Multiply by	To change	To	Multiply by
inches	centimeters	2.540	ounce-inches	newton-meters	.007062
feet	meters	.305	centimeters	inches	.394
yards	meters	.914	meters	feet	3.280
miles	kilometers	1.609	meters	yards	1.094
square inches	square centimeters	6.451	kilometers	miles	.621
square feet	square meters	.093	square centimeters	square inches	.155
square yards	square meters	.836	square meters	square feet	10.764
square miles	square kilometers	2.590	square meters	square yards	1.196
acres	square hectometers	.405	square kilometers	square miles	.386
cubic feet	cubic meters	.028	square hectometers	acres	2.471
cubic yards	cubic meters	.765	cubic meters	cubic feet	35.315
fluid ounces	milliliters	29.573	cubic meters	cubic yards	1.308
pints	liters	.473	milliliters	fluid ounces	.034
quarts	liters	.946	liters	pints	2.113
gallons	liters	3.785	liters	quarts	1.057
ounces	grams	28.349	liters	gallons	.264
pounds	kilograms	.454	grams	ounces	.035
short tons	metric tons	.907	kilograms	pounds	2.205
pound-feet	newton-meters	1.356	metric tons	short tons	1.102
pound-inches	newton-meters	.11296			

Temperature (Exact)

°F Fahrenheit temperature 5/9 (after subtracting 32) Celsius temperature °C

PIN : 033700-000